

Data Sheet



Article number: 433000014

Description: Rota-fix shaft-hub connection C 14x18

Note: Not self centering. Small radial dimensions

Measures

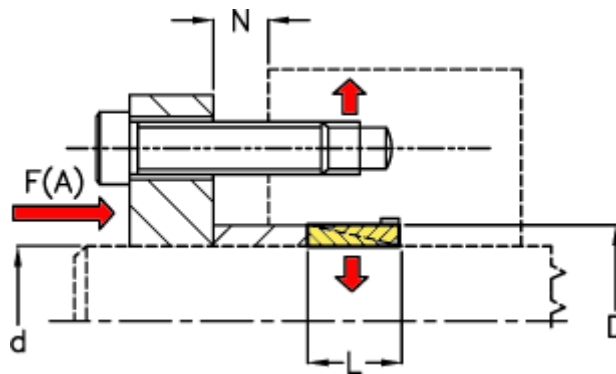

d mm = 14

D mm = 18

F(A) kN = 26

Fit tolerance = Aksel \varnothing ? 38 h6, Aksel \varnothing > 38 h8, Nav \varnothing ? 38 H7, Nav > \varnothing 38 H8

F kN torque = 3.0

L = 6.3

N1 = 3

N2 = 4

N3

N4

P N/mm² surface press

Surface roughness

T N m torque